



BLOOD GROOVE HYPERCHARGER

9990

Thank You For Choosing Kuryakyn!

Protect yourself and others from potential injury and property damage or loss. Pay close attention to all instructions, warnings, cautions, and notices regarding the installation, use, and care of this product.

WARNING

THIS INDICATION ALERTS YOU TO THE FACT THAT IGNORING THE CONTENTS DESCRIBED HEREIN CAN RESULT IN POTENTIAL DEATH OR SERIOUS INJURY.

NOTICE

This indication alerts you to the fact that ignoring the contents described herein may negatively affect product performance and functionality or damage the product itself or the product to which it is being attached.

THIS PRODUCT IS NOT LEGAL FOR SALE OR USE ON POLLUTION CONTROLLED VEHICLES.

ENSURE THAT THE FOLLOWING PARTS HAVE BEEN INCLUDED IN THE KIT:

- 1 Hypercharger Assembly with Hardware Bag Containing:
(3) 1/4"-20 X 1-5/8" Screws (2) #6-32 X 3/8" Screws (2) #6 Washers
- 1 Dual Velocity Ring in Bag Inside Hypercharger Assembly
- 1 Filter Element
- 1 Support Bracket
- 1 Breather Hardware Kit, including:
- 2 Breather Bolts
- 2 Breather Hoses
- 1 Breather Kit, including:
 - 1 Breather Adapter
 - 1 90° Barbed Fitting
 - 2 Straight Barbed Fitting — ONE USED
 - 1 16" Vacuum Hose
 - 1 Barbed "T" Fitting
 - 3 1/4"-20 x 1-1/2" Socket Head Cap Screws
 - 1 Gasket with Adhesive
 - 2 Gaskets without Adhesive
 - 4 4" Nylon Cable Ties
- 1 Installation Instructions

YOU WILL ALSO NEED:

Set of Hex Wrenches, Set of Combination Wrenches, Set of Torx Wrenches, Needle Nose Pliers, Side Cutters, Model/Year-Specific Service Manual

NOTICE

These installation instructions contain important information. Ensure that the end user receives this copy and is aware of its importance for future use.

WARNING

THE END USER'S SAFETY DEPENDS UPON PROPER INSTALLATION OF THIS PRODUCT. IF A STEP IN THESE INSTRUCTIONS IS NOT WITHIN YOUR CAPABILITIES OR YOU DO NOT HAVE THE CORRECT TOOLS, HAVE YOUR DEALER PERFORM THE PROCEDURE. IMPROPER INSTALLATION OF THIS PRODUCT COULD RESULT IN DEATH OR SERIOUS INJURY.

ACCIDENTAL VEHICLE START-UP COULD CAUSE DEATH OR SERIOUS INJURY, REMOVE THE MAIN FUSE BEFORE PROCEEDING.

INSTALLATION MAY REQUIRE CONTACT WITH THE ENGINE AND EXHAUST SYSTEM; ENSURE THAT IT HAS FULLY COOLED BEFORE BEGINNING TO PREVENT INJURY.

FUEL VAPORS ARE VERY FLAMMABLE! PERFORM THIS INSTALLATION IN A WELL VENTILATED AREA AWAY FROM SPARKS AND OPEN FLAMES. FUEL VAPORS MAY IGNITE CAUSING AN EXPLOSION THAT CAN LEAD TO SERIOUS INJURY OR DEATH.

NOTICE

Avoid damage to the motorcycle. Protect painted surfaces with a soft cloth or blanket.

STEP 1 Read and understand all steps in the instructions before starting the installation. Park the motorcycle on a hard, level surface and turn **IGN OFF**. Allow the engine and exhaust system to cool. Remove the main fuse.

STEP 2 Remove the existing air cleaner; refer to the model/year-specific service manual for procedure.

STEP 3 Remove the throttle and idle cables, fuel line, enrichener valve (choke), and VOES vacuum line; remove the carb from the intake manifold; re-jet the carb for best results; refer to the model/year-specific service manual for procedure.

STEP 4 Cut a 1-1/2" section of vacuum hose from the length included. Assemble the Barbed "T" Fitting and hoses as shown in **PIC 1**.

STEP 5 Connect the short section to the fitting on the manifold-side of the carb as shown in **PIC 1**.

STEP 6 Reinstall the carb. Reconnect and adjust the throttle and idle cables. Reinstall fuel line, enrichener valve (choke), and VOES vacuum line.

STEP 7 Remove and discard the adhesive backing from the included gasket; align it with the intake flange and press into place.

Align the support bracket with the intake flange; loosely attach it to each head with the included breather bolts.

Ensure all three mounting holes and the vent hole (10-o'clock position) are centered in the corresponding slots in the support bracket.

Ensure the support bracket contacts each head when it is in place across the front of the intake flange. If there is a gap between the heads and the support bracket, push the carb inward to eliminate the gap. Tightening the breather bolts when a gap is present will result in damage.

Tighten the breather bolts.

STEP 8 Assemble the breather adapter and fittings as shown in **PIC 2**.

Refer to **PIC 3 and 4**. Trim 1/4" from each end of ONE of the supplied breather hoses.

Connect the hose to the front breather bolt and the 90° fitting on the breather adapter.

Connect the remaining breather hose to the rear breather bolt and the straight barbed fitting on the breather adapter.

Secure the ends of the two hoses with the supplied cable ties; trim the cable tie ends.

STEP 9 Locate the Hypercharger Back Plate. Insert the three 1/4"-20 X 1-1/2" socket head cap screws through the back-plate mounting-holes from the inside. Place one of the included non-adhesive gaskets over the three mounting screws now protruding from the back of the Hypercharger back plate. **DO NOT** place a screw through the vent hole - the hole is in the 10-o'clock position.

STEP 10 Align the Back Plate and intake flange; secure the assembly to the intake flange with the three screws. **DO NOT over tighten the screws!**

STEP 11 Refer to **PIC 5**. Align the black plastic Dual Velocity ring with the Hypercharger vent hole. Press it all the way into place. The ring will "snap" into place.

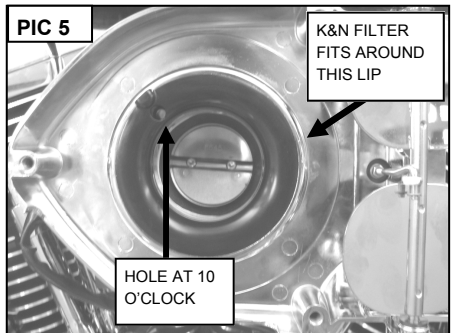
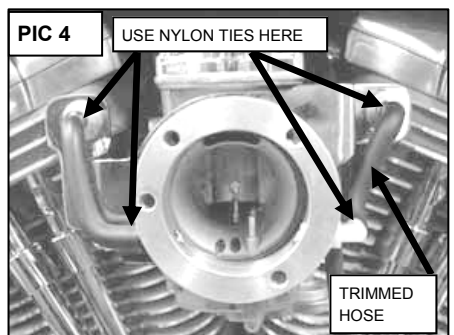
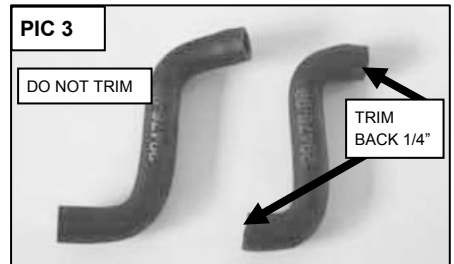
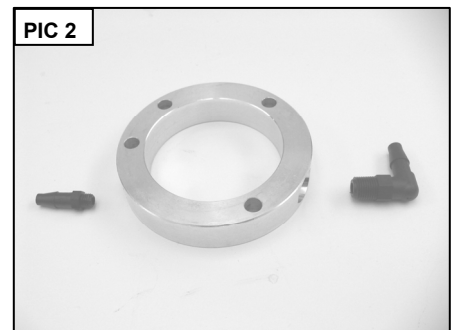
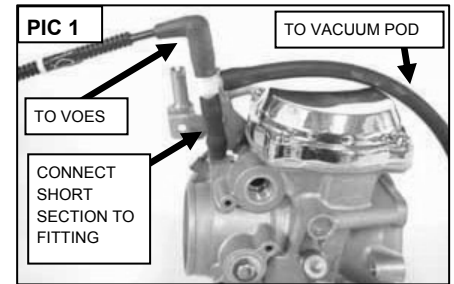



- STEP 12** Refer to **PIC 5**. Align the K&N air filter with the raised lip on the back plate.
- STEP 13** Locate the hardware bag that was with the Back Plate. Align the Front Cover over the back plate/filter; ensure that the front cover cut-out fits over the filter; loosely secure it to the back plate with the three 1/4"-20 X 1-5/8" screws. Thread one of the #6-32 X 3/8" screws through the top and bottom butterfly caps and into the front cover. Tighten the #6-32 X 3/8" screws securely. Tighten the 1/4"-20 X 1-5/8" screws securely.
- STEP 14** Attach the vacuum hose into the vacuum pod fitting on the back of the Hypercharger; it is pointing downward.
- STEP 15** Double check the tightness of all fasteners, re-install the main fuse, check for hose clearance and check throttle for correct operation, making sure it returns properly, before starting bike.

NOTICE

Follow K&N recommendations for proper use and cleaning of the air filter element.
K&N Filter Care Kit (p/n 85 available at kuryakyn.com)

WARNING

FAILURE OF THE THROTTLE TO RETURN COULD RESULT IN LOSS OF CONTROL CAUSING SERIOUS INJURY OR DEATH.

NOTICE

Proper tuning is important. Carbureted bikes should be re-jetted and fuel injected bikes should be tuned with a TTS MasterTune tuning system (calibrations available at www.kuryakyn.com) or Vance & Hines FP3 (calibrations available at <http://fp3.vanceandhines.com/download>) by an experienced tuner, on a dyno, with an exhaust gas analyzer.

It is the end user's responsibility to ensure that all fasteners (including pre-assembled) are tightened before operation of the motorcycle. Kuryakyn will not provide warranty coverage on products or components lost or damaged due to improper installation or lack of maintenance. Periodic inspection and maintenance are required on all fasteners.

LIMITED WARRANTY

Kuryakyn warrants that any Kuryakyn products sold hereunder, shall be free of defects in materials & workmanship for a period of one (1) year from the date of purchase by the consumer excepting the following provisions:

1. Kuryakyn shall have no obligation in the event the customer is unable to provide a receipt showing the date the customer purchased the product(s).
2. The product must be properly installed, maintained & operated under normal conditions.
3. Kuryakyn shall not be liable for any consequential & incidental damages, including labor & paint, resulting from failure of a Kuryakyn product, failure to deliver, delay in delivery, delivery in nonconforming condition, or for any breach of contract or duty between Kuryakyn & a customer.
4. Kuryakyn products are often intended for use in specific applications. Kuryakyn makes no warranty if a Kuryakyn product is used in applications other than intended.
5. Kuryakyn electrical products are warranted for one (1) year from the date of purchase by the consumer. L.E.D.'s contained in components of Kuryakyn products will be warranted for defects in materials & workmanship for 3 years from the date of purchase whereas all other components shall be warranted for one (1) year.
6. Merchandise purchased directly from Internet auction sites or any other third party seller is considered sold as is & shall not carry a Kuryakyn warranty. All warranty claims must be directed to the original seller. If unsure please contact the seller to verify they are an authorized Kuryakyn retailer.

RETURN POLICY

Merchandise determined to be defective may be returned up to one year from the date of purchase. Returns must be processed through original seller. Returned merchandise for any other reason other than warranty claims must be in like new condition & subject to a 20% restocking fee. All returns are subject to inspection for determination of full or partial credit. Any returned part that shows evidence of being used or installed contrary to manufacturer's instructions, &/or subjected to improper handling, packaging or return shipping by the customer, will not be eligible for exchange, refund or warranty consideration. All returned electrical items will be inspected & tested. If electrical item is deemed functional, no credit will be issued & item will be returned. All sales are final on discontinued or closeout merchandise.

EMISSIONS NOTICE

The California Air Resources Board (CARB) does not permit the use of aftermarket emission-related parts(s) that alter the performance of OEM emission-related devices unless CARB has issued an Executive Order, other than on racing vehicles on closed courses. Check your local laws and manufacturer's information.