

## INSTALLATION INSTRUCTIONS

### NIGHTCRAWLERS HEADLIGHT AND ACCENT LIGHT KIT FOR JEEP 2480

#### THANK YOU FOR CHOOSING KURYAKYN!

Protect yourself and others from possible injury and property damage or loss. Pay close attention to all instructions, warnings, cautions, and notices regarding the installation, use, and care of this product.

- ⚠ WARNING** THIS INDICATION ALERTS YOU TO THE FACT THAT IGNORING THE CONTENTS DESCRIBED HEREIN CAN RESULT IN POTENTIAL DEATH OR SERIOUS INJURY.
- ⚠ CAUTION** THIS INDICATION ALERTS YOU TO THE FACT THAT IGNORING THE CONTENTS DESCRIBED HEREIN CAN RESULT IN MINOR OR MODERATE POTENTIAL INJURY.
- NOTICE** THIS INDICATION ALERTS YOU TO THE FACT THAT IGNORING THE CONTENTS DESCRIBED HEREIN MAY NEGATIVELY AFFECT PRODUCT PERFORMANCE AND FUNCTIONALITY OR DAMAGE THE PRODUCT ITSELF OR THE PRODUCT TO WHICH IT IS BEING ATTACHED.

#### ENSURE THAT THE FOLLOWING PARTS HAVE BEEN INCLUDED IN THE KIT:

2	7" Headlights	10	48" Extension Cords
2	Headlight Adapters	4	Loop Connectors
6	PRISM+ 8" Flex-Strip Light	24	6" Cable Ties
1	PRISM+ Bluetooth Automotive Controller	10	Cable Tie Mount
1	PRISM+ Remote		

#### YOU WILL ALSO NEED:

Torx screwdriver set, Phillips screw driver, wire stripper, electrical tape, masking tape, dremel or file

- NOTICE** THESE INSTALLATION INSTRUCTIONS CONTAIN IMPORTANT INFORMATION. ENSURE THE END USER RECEIVES THIS COPY AND IS AWARE OF ITS IMPORTANCE FOR FUTURE USE.

**MODIFICATIONS MAY NEED TO BE MADE TO YOUR OEM HEADLIGHT BRACKET BUCKET. FOR THE NIGHTCRAWLER HEADLIGHT TO PROPERLY SIT IN THE OEM BRACKET BUCKET YOU MAY NEED TO FILE AWAY A FEW SMALL SECTIONS FROM THE BUCKET. REFER TO STEP 19 ON PAGE 5, AND PIC 17-20 FOR A CLOSER LOOK AT THE MODIFICATIONS THAT NEED TO HAPPEN BEFORE STARTING THE INSTALLATION PROCESS.**



- NOTICE** REFER TO THE LAST PAGE OF THE INSTALLATION INSTRUCTIONS FOR L.E.D. COUNTS FOR EACH VARIATION OF PRISM+ LIGHTS. BLUETOOTH CONTROLLERS HAVE A MAX CAPACITY OF 250 L.E.D.S CONNECTED TO IT AT A TIME. MAX CAPACITY PER CHANNEL IS 100 L.E.D.S, BUT THE CONTROLLER SHOULD NEVER EXCEED A TOTAL OF 250 L.E.D.S CONNECTED TO IT.

**STEP 1** Read and understand all steps in the instructions before starting the installation. Park the vehicle on a hard, level surface and turn off the ignition. Let your vehicle cool.

## INSTALLATION INSTRUCTIONS

### NIGHTCRAWLERS HEADLIGHT AND ACCENT LIGHT KIT FOR JEEP 2480

-CONTINUED-

**STEP 2** Refer to PIC 2 and 3. If applicable, open the hood of your vehicle and remove the existing grill. Set mounting hardware and grill aside, they will be reused.

*Note: The grill may not need to be removed to gain access the headlight, but instead only remove the outer trim ring of the headlight. Set hardware and outer trim ring aside.*

*Note: Jeep grills and fasteners will vary. Refer to vehicle's service manual for assistance.*



**STEP 3** Refer to PIC 4 and 5. Remove the trim ring and hardware that is holding the existing headlight in place. Set mounting hardware and ring aside, they will be reused.



**STEP 4** Gently take the headlight out, disconnect the wires, and set the light aside.

*Note: Headlight attachment and assembly will vary. Refer to vehicle's service manual for assistance.*

**STEP 5** Refer to PIC 6 and 7. Locate provided adapter. If applicable, connect the adapter to the OEM headlight's wiring harness.

*Note: Headlight electrical fasteners will vary. If your jeep's headlights are connected by a three-blade plug, the provided adapter is not needed.*

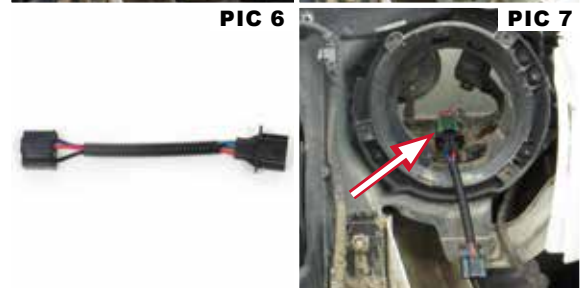

**STEP 6** Refer to PIC 8 and 9. Locate provided Headlight. Connect the headlight's 3-blade connector to the 3-blade plug on the adapter, or OEM 3-blade plug. Turn vehicle on and test proper function of headlight. Turn vehicle off after testing.

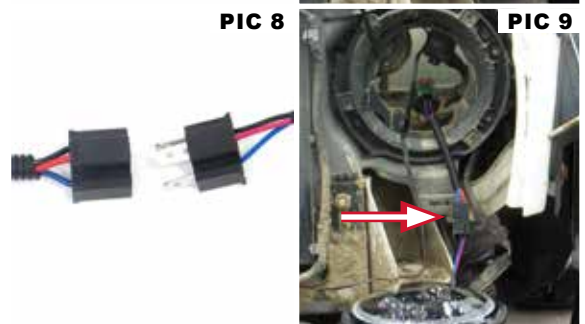

**STEP 7** Refer to PIC 10 and 11. Locate provided Prism+ Remote and Prism+ Bluetooth Controller. Gain access to your vehicle's battery for installation of the controller and remote.

*Note: Battery location and access will vary. Refer to your vehicle's service manual for assistance.*

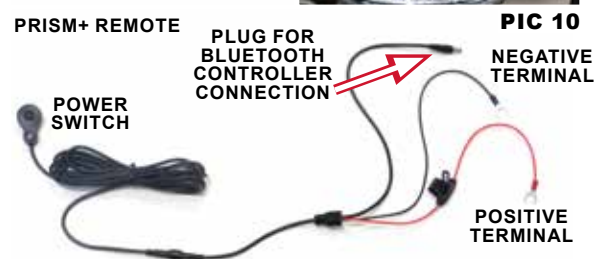

## INSTALLATION INSTRUCTIONS

### NIGHTCRAWLERS HEADLIGHT AND ACCENT LIGHT KIT FOR JEEP 2480

-CONTINUED-

**STEP 8** Fasten the controller and remote's positive hook terminals (red wire with hook terminal) to the positive post on the battery. Fasten the remote's negative hook terminal (black wire with hook terminal) to the negative post on the battery. Fully secure hooks in place.

Do **NOT** connect pigtail wires labeled "brake", "left", "right" at this time.

**STEP 9** Refer to PIC 12 and 13. Connect the remote to the bluetooth controller.

**STEP 10** Refer to PIC 14. Locate provided four (4) extension cords. Connect the extension cords to the Bluetooth Controller. Be aware of the four different channels on the controller: front left, front right, rear left, and rear right. Left sides = driver's side, right sides = passenger's side.

**STEP 11** Locate provided six (6) PRISM+ 8" Flex-Strip Lights and two (2) loop connectors. Connect three (3) strip lights together and place a loop connector on the end of it. Repeat the same process with remaining strip lights and loop connector.

*Note: Refer to PIC 15. Make note of the raised dot and the Kuryakyn K-shield logo on opposite ends on each part. When connecting cords to cords, cords to lights, or lights to lights be sure that the raised dot and K-shield logo are both visible when connecting. When parts are connected, the K-shield logos of those parts should be visible on the same side. If within your chain of cords and lights a shield is facing in the opposite direction, it is connected incorrectly.*

**STEP 12** Connect the extension cord from the front left channel to the driver's side headlight, and the extension cord from the front right channel to the passenger's side headlight. Connect one of the three strip lights with a loop connector assembly to the rear left channel and the other one to the rear right channel.

**STEP 13** Turn on the Bluetooth Controller remote (blue light turns on), open the Kuryakyn Prism+ App on your phone, and pair the two devices. Test for proper function of the headlight and strip lights before fully installing them.

#### NOTICE

**TO ENSURE PROPER FUNCTIONALITY OF THE HEADLIGHT, BE SURE THEY ARE CONNECTED TO THEIR PROPER CHANNEL: FRONT LEFT OR FRONT RIGHT.**

PRISM+ BLUETOOTH CONTROLLER **PIC 11**

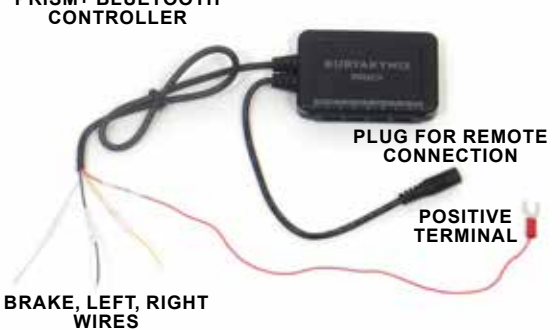

BRAKE, LEFT, RIGHT WIRES

**PIC 12**

**PIC 13**



REMOTE

BLUETOOTH CONTROLLER

**PIC 14**



**PIC 15**

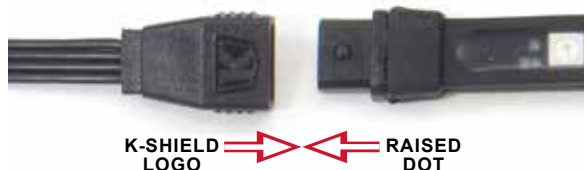

K-SHIELD LOGO

RAISED DOT

## INSTALLATION INSTRUCTIONS

### NIGHTCRAWLERS HEADLIGHT AND ACCENT LIGHT KIT FOR JEEP

2480

-CONTINUED-

#### OPTIONAL

##### BRAKE-REAR TURN SIGNAL FUNCTIONALITY

- Brake-rear turn light features work when "RIDE" mode is turned on in the Kuryakyn Prism+ App.

**STEP 14** IF NOT USING THE BRAKE-REAR TURN FEATURE, OR IT IS NOT APPLICABLE TO YOUR VEHICLE:  
Use electrical tape to individually wrap the exposed pigtail wires, and secure them in a safe place. Proceed to Step 16.

**STEP 15** CONNECTION OF BRAKE-REAR TURN PIGTAILS, IF APPLICABLE TO VEHICLE:

Refer to PIC 16.

Be aware of the pigtail wires coming from the controller: red = battery, white = brake, black = left turn signal, and yellow = right turn signal.

On the vehicle, locate a brake light wire, a left turn signal wire, and a right turn signal wire (colors of wires will vary depending on vehicle models - refer to your service manual for assistance).

Connect the corresponding pigtail wires to the vehicle wires.

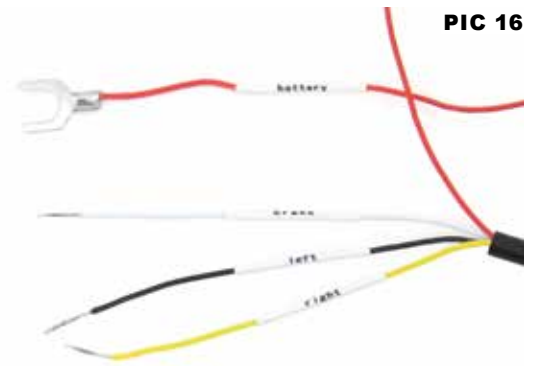

#### NOTICE

TO ENSURE PROPER FUNCTIONALITY OF THE LIGHTS (BRAKING AND TURN SIGNALS, IF APPLICABLE), BE SURE THEY ARE CONNECTED TO THEIR PROPER CHANNEL: FRONT LEFT, FRONT RIGHT, REAR LEFT, OR REAR RIGHT.

**STEP 16** After testing the headlight and strip lights, turn the remote off and disconnect the lights from the bluetooth controller for the time being. Disconnect all of the strip lights from each other. Leave extension cords plugged into the controller. Disconnect the remote from the controller.

#### NOTICE

THE THERMAL LIMIT OF THE MODULE IS 55°C (131°F). IF THE BLUETOOTH CONTROLLER EXCEEDS THESE TEMPERATURES PRISM+ LIGHTS MAY MALFUNCTION.

**STEP 17** Set the controller within a safe open space located in or around the vehicle's frame near the battery.

## INSTALLATION INSTRUCTIONS

### NIGHTCRAWLERS HEADLIGHT AND ACCENT LIGHT KIT FOR JEEP

2480

-CONTINUED-

**STEP 18** Align and test fit the headlight into the OEM headlight bracket bucket. Be aware of the three clocking tabs on the back of the headlight, and the three notches on the bucket that align with the tabs. Determine if modifications need to be made to the OEM headlight bucket for the headlight to properly seat into the three clocking notches of the bucket. Remove the headlight from the bucket.

**STEP 19** IF MODIFICATIONS DO NOT NEED TO BE MADE TO THE OEM HEADLIGHT BUCKET:  
Proceed to step 21.

**IF MODIFICATIONS NEED TO BE MADE TO THE OEM HEADLIGHT BUCKET:**

Refer to PIC 17 through 20. Very carefully remove the ribbed surface located on all three clocking notches on the OEM headlight bracket bucket. Remove a little at a time and re-test fit the light into the bucket. If the headlight does not properly seat into the bucket, remove the headlight and remove a little more of the ribbed surface, and maybe a little bit of the sides of the notches, until the back of the headlight is able to sit flush with the bracket bucket.

*Note: Removal of the surface areas of the bracket bucket should be attainable with the buckets left on the vehicle. You can remove the buckets from the vehicle for ease of modifications. Unfasten the headlight adjustment torx screw(s) from the bucket. Once adjustment screw(s) are removed, gently pull the bucket out. Refer to vehicle's service manual for assistance.*

**STEP 20** Reinstall the OEM headlight bucket if applicable.

**STEP 21** Route the headlight's bluetooth cord through the bracket bucket and under the hood area accordingly and connect the headlight to the Bluetooth Controller, or to other Prism+ extension cords or lights.

**STEP 22** Refer to PIC 21. Tuck all wiring into headlight housing. Align and place the headlight into the bracket bucket, being sure the clocking tabs are properly aligned and the headlight is flush to the surface of the bucket. Use the OEM trim ring and hardware that was removed in Step 3 to fasten the headlight to the vehicle. Fully tighten all hardware.

JK/JKU LEFT SIDE BUCKET SHOWN, OFF VEHICLE



PIC 17

PIC 18



PIC 19

PIC 20

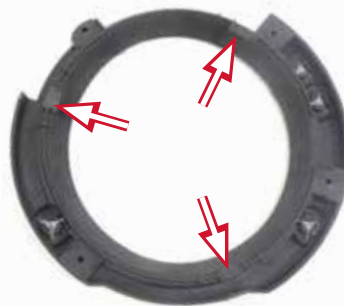

PIC 21

## INSTALLATION INSTRUCTIONS

### NIGHTCRAWLERS HEADLIGHT AND ACCENT LIGHT KIT FOR JEEP 2480

-CONTINUED-

- STEP 23** Locate provided PRISM+ 8" Flex-Strip Lights. Determine areas of the vehicle you wish to apply the lights to. Test fit the lights and mark the desired locations with masking tape. Determine which provided extension cords and connectors will be suitable for your desired locations. Make adjustments to placement where needed. **DO NOT INSTALL PARTS AT THIS TIME!**

*Note: Refer to FIG 1 for a suggestion, not a requirement, of where to install Prism+ lights. Get creative and have fun!*

FIG 1

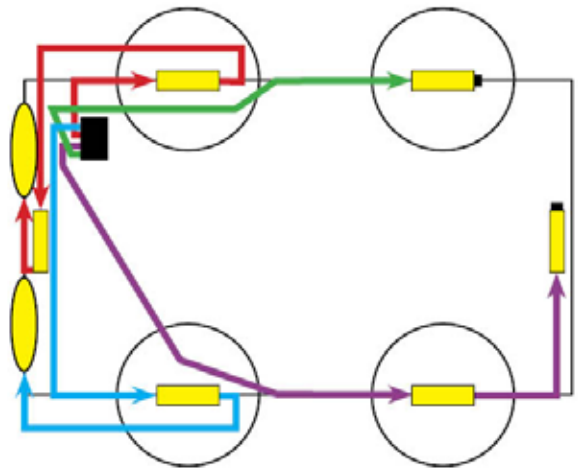

#### NOTICE

**ENSURE PROPER ADHESION OF THIS PRODUCT. REMOVE ALL GREASE, OIL, BUGS, DIRT, AND OTHER DEBRIS (INCLUDING WAX AND POLISH) FROM THE INSTALLATION AREA. KURYAKYN WILL NOT PROVIDE WARRANTY COVERAGE ON PRODUCTS OR COMPONENTS LOST OR DAMAGED DUE TO IMPROPER INSTALLATION.**

**DO NOT ATTEMPT THIS INSTALLATION IN TEMPERATURES BELOW 50°F (10°C). PROPER ADHESIVE BONDING ONLY OCCURS ABOVE 50°F (10°C).**

- STEP 24** Using warm soapy water and a clean rag, remove all dirt and debris from the installation area for the 8" strip lights; allow the area to dry completely.
- STEP 25** Double check placement of the strip lights, and needed extension cords, before applying the lights to any surface.
- STEP 26** Use your fingernail to rub the adhesive backing; this will activate the adhesive. Do not remove backing until actually placing lights on vehicle.
- STEP 27** Connect lights to the extension cords. Double check placement of the strip lights, and needed extension cords, before applying the lights to any surface.
- STEP 28** Remove and discard backing from light's adhesive backer. Align and place light to vehicle. Press into place for one minute; full bonding will occur after 24 hours.

*Note: If the vehicle is going to be operated before full bonding occurs, secure the strip lights to the vehicle with a good quality masking or painter's tape.*

- STEP 29** Refer to PIC 22. Locate (2) two provided loop connectors. For the strip lights on the rear left and rear right channels, connect a loop connector on the very last light of the connection of cords and lights. Be sure the raised dot on the Loop Connector is aligned with the K-shield logo on the light.



STRIP LIGHT



PIC 22

LOOP CONNECTOR

## INSTALLATION INSTRUCTIONS

### NIGHTCRAWLERS HEADLIGHT AND ACCENT LIGHT KIT FOR JEEP 2480

-CONTINUED-

**STEP 30** Refer to PIC 23 and 24. Determine placement of the Prism+ Remote. Disconnect the remote from it's long extension cord. Set the remote in desired location, but do not install it. Feed the remote's plug into the inner frame area under the hood, and back to the extension cord from which it was disconnected from. Connect remote to bluetooth controller.

*Note: If you want the remote's power switch to be inside the interior of the vehicle, there may be an existing hole with a grommet in the fire wall that you can pass the remote's plug through. If an existing hole/grommet does not exist, you may need to drill a small hole through the fire wall for you to pass the remote's plug through.*

**STEP 31** Test functionality of the remote.

**STEP 32** Refer to PIC 25. Remove and discard adhesive backer from the Prism+ Remote. Align and place in desired location. Press into place for one minute; full bonding will occur after 24 hours.

**STEP 33** Locate provided cable ties and cable tie mounts. Secure all cords in a safe place. Ensure that cords are secured away from any moving parts, excessive heat or pinch points.

#### NOTICE

**SECURE ALL WIRING AWAY FROM ANY MOVING PARTS, PINCH POINTS OR EXTREME HEAT. KURYAKYN WILL NOT ISSUE A WARRANTY ON ANY ELECTRICAL COMPONENT THAT FAILS DUE TO PINCHED, CRIMPED, BROKEN, ABRADED, MELTED OR FRAYED WIRES.**

**STEP 34** Retest function of lights. Ensure all of the lights properly function before operating vehicle.

**STEP 35** Adjust the aim of the headlights. Refer to instructions and FIG 2 on page 8, or refer to your vehicle's service manual, for additional help.

**STEP 36** If applicable, reinstall the vehicle's grill or outer trim rings reusing parts and hardware that were removed in Step 2.

#### NOTICE

**IT IS THE INSTALLER'S RESPONSIBILITY TO ENSURE THAT ALL OF THE FASTENERS (INCLUDING PRE-ASSEMBLED) ARE TIGHTENED BEFORE OPERATION OF THE MOTORCYCLE. KURYAKYN WILL NOT PROVIDE WARRANTY COVERAGE ON PRODUCTS OR COMPONENTS LOST DUE TO IMPROPER INSTALLATION OR LACK OF MAINTENANCE. PERIODIC INSPECTION AND MAINTENANCE ARE REQUIRED ON ALL FASTENERS.**

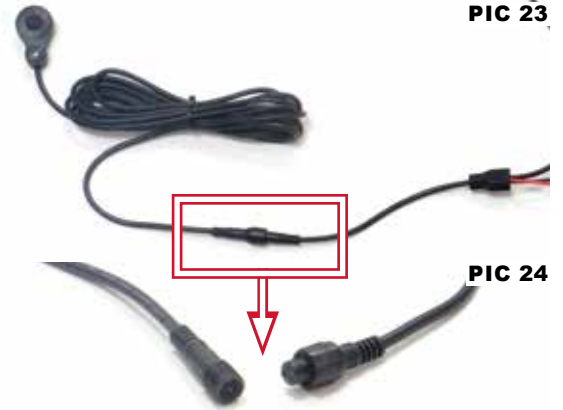

PIC 23

PIC 24



PIC 25

**DETERMINE PLACEMENT OF REMOTE AND REMOVE ADHESIVE BACKER FOR FINAL PLACEMENT**



FINAL

## INSTALLATION INSTRUCTIONS

### NIGHTCRAWLERS HEADLIGHT AND ACCENT LIGHT KIT FOR JEEP 2480

-CONTINUED-

#### ADJUSTING HEADLIGHT AIM

Refer to FIG 2. Before adjusting the lights check the following things:

- Proper tire pressure inflation.
- No build up of mud, snow, or ice on the under-body of the vehicle.
- No additional cargo weight in the vehicle, except for the driver (no passengers).
- Fuel tank is full.
- The suspension height is correct.
- Parked on a flat surface.

Choose a wall that is in minimal light. Tape a line 25 ft. away from, and parallel with, the wall. Park the vehicle to align with the 25 ft. line. On the parked vehicle measure the distance from the ground to the center of the headlight. Using masking tape and a level, create a horizontal line on the wall using the ground to center measurements.

On one of the outside edges of the parked jeep, place a perpendicular line on the 25 ft. marker line. This will be the vertical zero reference. Make a vertical tape line on the wall in alignment with the vertical zero reference. Measure the distance between vertical zero reference line and the vertical center of the nearest headlight. Take this measurement and mark it on the wall. Measure the distance between the vertical center points of both headlights. Take this measurement and mark the second headlight cross line on the wall.

Make adjustments to the headlight position by tightening or loosening the adjustment torx screw on the headlight bucket.

The headlight is aligned when the LOW beams are just below the horizontal line on the wall and the HIGH beams should split the cross hairs on the wall. Verify the headlight's alignment and adjust it if necessary.

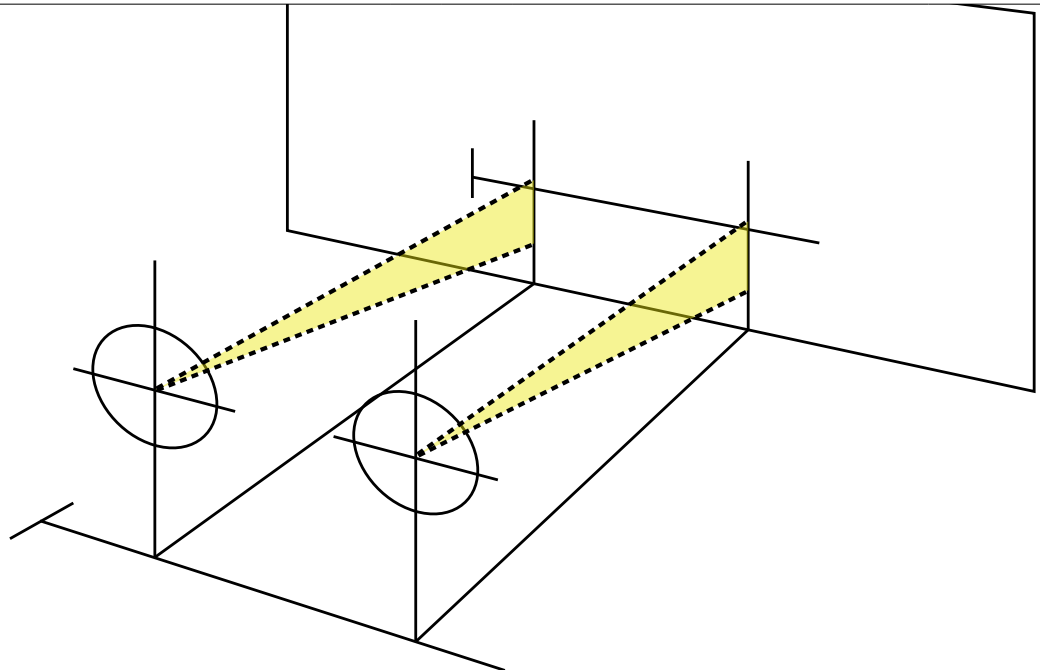

FIG 2





## INSTALLATION INSTRUCTIONS

### NIGHTCRAWLERS HEADLIGHT AND ACCENT LIGHT KIT FOR JEEP 2480

-CONTINUED-

#### LIMITED WARRANTY

Kuryakyn warrants that any Kuryakyn products sold hereunder, shall be free of defects in materials & workmanship for a period of one (1) year from the date of purchase by the consumer excepting the following provisions:

1. Kuryakyn shall have no obligation in the event the customer is unable to provide a receipt showing the date the customer purchased the product(s).
2. The product must be properly installed, maintained & operated under normal conditions.
3. Kuryakyn shall not be liable for any consequential & incidental damages, including labor & paint, resulting from failure of a Kuryakyn product, failure to deliver, delay in delivery, delivery in nonconforming condition, or for any breach of contract or duty between Kuryakyn & a customer.
4. Kuryakyn products are often intended for use in specific applications. Kuryakyn makes no warranty if a Kuryakyn product is used in applications other than intended.
5. Kuryakyn electrical products are warranted for one (1) year from the date of purchase by the consumer. L.E.D.'s contained in components of Kuryakyn products will be warranted for defects in materials & workmanship for 3 years from the date of purchase whereas all other components shall be warranted for one (1) year.
6. All warranty claims must be directed to the place of purchase. Merchandise sold through internet auction sites or any other unauthorized reseller shall not carry a Kuryakyn warranty. If unsure, please contact the place of purchase to verify they are an authorized Kuryakyn reseller.

#### RETURN POLICY

Merchandise determined to be defective may be returned up to one year from the date of purchase. Returns must be processed through original seller. Returned merchandise for any other reason other than warranty claims must be in like new condition & subject to a 20% restocking fee. All returns are subject to inspection for determination of full or partial credit. Any returned part that shows evidence of being used or installed contrary to manufacturer's instructions, &/or subjected to improper handling, packaging or return shipping by the customer, will not be eligible for exchange, refund or warranty consideration. All returned electrical items will be inspected & tested. If electrical item is deemed functional, no credit will be issued & item will be returned. All sales are final on discontinued or closeout merchandise.

©2015 KURYAKYN HOLDINGS, LLC ALL RIGHTS RESERVED

KURYAKYN, KURYAKYN K logo and the marks appearing on this instruction sheet are registered and common law trademarks of Kuryakyn Holdings except noted third-party trademarks. A full listing of trademarks and trademark registrations owned by Kuryakyn Holdings can be found at [www.kuryakyn.com/legal-notice](http://www.kuryakyn.com/legal-notice).

Emissions Notice: The California Air Resources Board (CARB) does not permit the use of aftermarket emission-related parts(s) that alter the performance of OEM emission-related devices unless CARB has issued an Executive Order, other than on racing vehicles on closed courses. Check your local laws and manufacturer's information.

Listed Manufacturers and product model names are for reference only. All product and company names are trademarks or registered trademarks of their respective holders. Use of them does not imply any affiliation with or endorsement by them. All specifications are subject to change without notice.

For additional information on third-party product and company names, please consult our Web page at [www.kuryakyn.com/legal-notice](http://www.kuryakyn.com/legal-notice)



## INSTALLATION INSTRUCTIONS

### NIGHTCRAWLERS HEADLIGHT AND ACCENT LIGHT KIT FOR JEEP 2480

-CONTINUED-

#### FCC WARNING STATEMENT

This equipment has been tested and found to comply with the limits for a Class B digital device, pursuant to part 15 of the FCC Rules. These limits are designed to provide reasonable protection against harmful interference in a residential installation. This equipment generates, uses and can radiate radio frequency energy and if not installed and used in accordance with the instructions, may cause harmful interference to radio communications. However there is no guarantee that interference will not occur in particular installation. If this equipment does cause harmful interference to radio or television reception, which can be determined by turning the equipment off and on, the user is encouraged to try to correct the interference by one or more of the following measures:

- Reorient or relocate the receiving antenna.
- Increase the separation between the equipment and receiver.
- Connect the equipment into an outlet on a circuit different from that to which the receiver is connected.
- Consult the dealer or an experienced radio/TV technician for help.

**CAUTION:** any changes or modifications to this device not explicitly approved by manufacturer could void your authority to operate this equipment. This device complies with part 15 of the FCC Rules. Operation is subject to the following two conditions: (1) this device may not cause harmful interference, and (2) this device must accept any interference received, including interference that may cause undesired operation.

The device has been evaluated to meet general RF exposure requirement. The device can be used in portable exposure condition without restriction.

---

## INSTALLATION INSTRUCTIONS

### NIGHTCRAWLERS HEADLIGHT AND ACCENT LIGHT KIT FOR JEEP 2480

-CONTINUED-

**NOTICE**

REFER TO THE L.E.D. COUNT TABLE FOR EACH VARIATION OF PRISM+ LIGHTS. BLUETOOTH CONTROLLERS HAVE A MAX CAPACITY OF 250 L.E.D.S CONNECTED TO IT AT A TIME. MAX CAPACITY PER CHANNEL IS 100 L.E.D.S, BUT THE CONTROLLER SHOULD NEVER EXCEED A TOTAL OF 250 L.E.D.S CONNECTED TO IT.

PRISM COMPONENTS	L.E.D. COUNT
HEADLIGHT 7"	48
ROULETTE	16
FLARE	8
4" STRIP	8
8" STRIP	16
POD*	8 L.E.D. COUNT (*4 CONTROLLER READ COUNT)

\*The bluetooth controller reads a pod light as 4 L.E.D.s, even though they have a total of 8 L.E.D.s.

#### CREATING A SINGLE CHAIN OF PODS AND/OR STRIP LIGHTS:

Refer to FIG 1.1. Do not exceed the 100 L.E.D. maximum capacity per channel. Place a loop connector on the very end of the chain of lights.

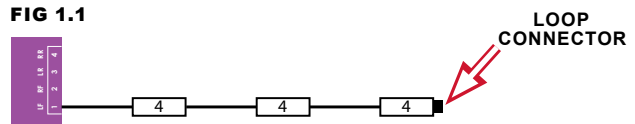

#### CREATING A SINGLE CHAIN OF PODS AND/OR STRIP LIGHTS WITH A HEADLIGHT, ROULETTE WHEEL, OR FLARE LIGHT:

Refer to FIG 2.1. Do not exceed the 100 L.E.D. maximum capacity per channel. Place Headlight or Roulette Wheel on the end of the chain.

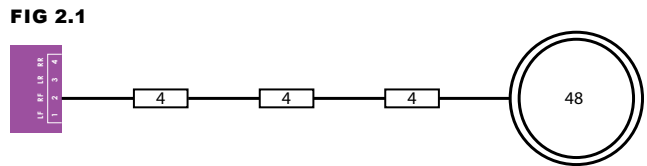

#### USING A Y-CONNECTOR WITH A HEADLIGHT, THE PASSING LIGHTS, A ROULETTE WHEEL, OR THE FLARE LIGHTS:

Refer to FIG 3.1. When Y-Connectors are used with a Headlight, the Passing Lights, a Roulette Wheel, or the Flare Lights, each branch of the Y-Connector needs to have the same amount of L.E.D.s to function properly. Lights can be placed before a Y-Connector as long as the 100 L.E.D. maximum capacity per channel is not exceeded.

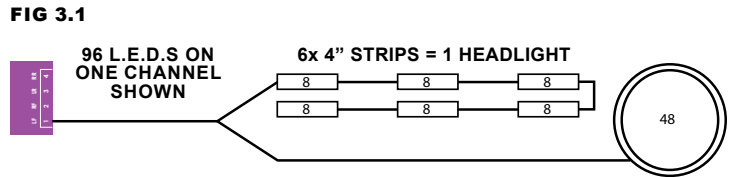

When balancing a branch using Pod Lights the controller reads them as 4 L.E.D.s, but the actual count is 8 L.E.D.s per Pod. The 8 count is used in the overall total of L.E.D.s on a channel. Make sure not to exceed the 100 L.E.D. maximum capacity per channel.

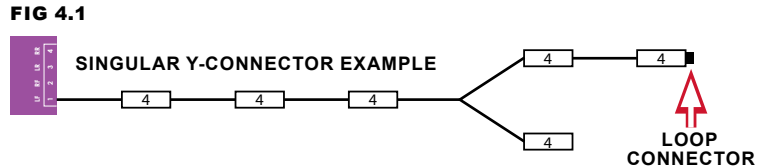

#### USING A Y-CONNECTOR WITH PODS AND/OR STRIP LIGHTS ONLY:

Refer to FIG 4.1 and 4.2. When using Y-Connectors, the branch with the most L.E.D.s on it needs to have a loop connector added to the end of it.

