

## INSTALLATION INSTRUCTIONS

### ORBIT PRISM 7" LED HEADLIGHT

2461

#### THANK YOU FOR CHOOSING KURYAKYN!

Protect yourself and others from possible injury and property damage or loss. Pay close attention to all instructions, warnings, cautions, and notices regarding the installation, use, and care of this product.

**WARNING** THIS INDICATION ALERTS YOU TO THE FACT THAT IGNORING THE CONTENTS DESCRIBED HEREIN CAN RESULT IN POTENTIAL DEATH OR SERIOUS INJURY.

**CAUTION** THIS INDICATION ALERTS YOU TO THE FACT THAT IGNORING THE CONTENTS DESCRIBED HEREIN CAN RESULT IN MINOR OR MODERATE POTENTIAL INJURY.

**NOTICE** THIS INDICATION ALERTS YOU TO THE FACT THAT IGNORING THE CONTENTS DESCRIBED HEREIN MAY NEGATIVELY AFFECT PRODUCT PERFORMANCE AND FUNCTIONALITY OR DAMAGE THE PRODUCT ITSELF OR THE PRODUCT TO WHICH IT IS BEING ATTACHED.

#### ENSURE THAT THE FOLLOWING PARTS HAVE BEEN INCLUDED IN THE KIT:

- |   |                                   |   |  |
|---|-----------------------------------|---|--|
| 1 | Headlight with BT/RGB Halo        | 1 | Hardware Kit, containing:                      |
| 1 | Headlight Mounting Bracket        | 3 | Springs  |
| 1 | Headlight Mounting Bracket Bottom | 3 | M6 X 1.0 X 35MM Button Socket Head Cap Screws  |
| 1 | Bluetooth Controller              | 2 | M8 X 1.25 X 10MM Button Socket Head Cap Screws |
| 1 | Bluetooth Harness                 | 2 | 8MM Split Washers                              |
|   |                                   | 1 | Self Tapped Screw                              |

#### YOU WILL ALSO NEED:

Hex wrench set, Phillips screw driver, wire stripper, electrical and masking tape

**NOTICE** THESE INSTALLATION INSTRUCTIONS CONTAIN IMPORTANT INFORMATION. ENSURE THE END USER RECEIVES THIS COPY AND IS AWARE OF ITS IMPORTANCE FOR FUTURE USE.

**STEP 1** Read and understand all steps in the instructions before starting the installation. Park the motorcycle on a hard, level surface and turn off the ignition. Let motorcycle cool. Remove main fuse.

**WARNING** THE END USER'S SAFETY DEPENDS UPON PROPER INSTALLATION OF THIS PRODUCT. IF A STEP IN THESE INSTRUCTIONS IS NOT WITHIN YOUR CAPABILITIES OR YOU DO NOT HAVE THE CORRECT TOOLS, HAVE YOUR DEALER PERFORM THE PROCEDURE. IMPROPER INSTALLATION OF THIS PRODUCT COULD RESULT IN DEATH OR SERIOUS INJURY.

ACCIDENTAL VEHICLE START-UP COULD CAUSE DEATH OR SERIOUS INJURY, REMOVE THE MAIN FUSE BEFORE PROCEEDING.

**NOTICE** AVOID DAMAGE TO THE MOTORCYCLE. PROTECT PAINTED SURFACES WITH A SOFT CLOTH OR BLANKET

**STEP 2** Remove the headlight trim. Set trim and hardware aside. Hardware will not be reused, but the trim will.

*Note: Headlight trim and assembly will vary. Refer to motorcycle service manual for assistance.*

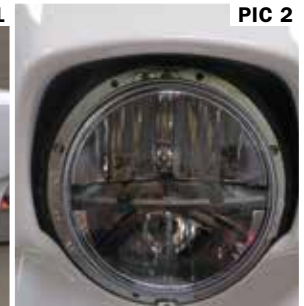

**KURYAKYN.COM**

866 277 9598 | INFO@KURYAKYN.COM  
454 COUNTY ROAD VV SOMERSET, WI 54025

## INSTALLATION INSTRUCTIONS

### ORBIT PRISM 7" LED HEADLIGHT

2461

-CONTINUED-

- STEP 3** Refer to PIC 3 and 4. Remove the hardware that is holding the existing headlight in place, and set it aside until later. Gently take the headlight out, disconnect the wires, and set light aside. It will not be reused.

*Note: Headlight attachment and assembly will vary. Refer to motorcycle service manual for assistance.*



- STEP 4** Refer to PIC 5. Locate Orbit Headlight, Headlight Mounting Bracket, Headlight Mounting Bracket Bottom, two (2) M8 Screws, two (2) 8MM Split Washers, three (3) M6 Screws, and three (3) Springs. Apply loc-tight to all screw threads.

Place on a flat clean surface, with the headlight upside down, as seen in PIC 5.

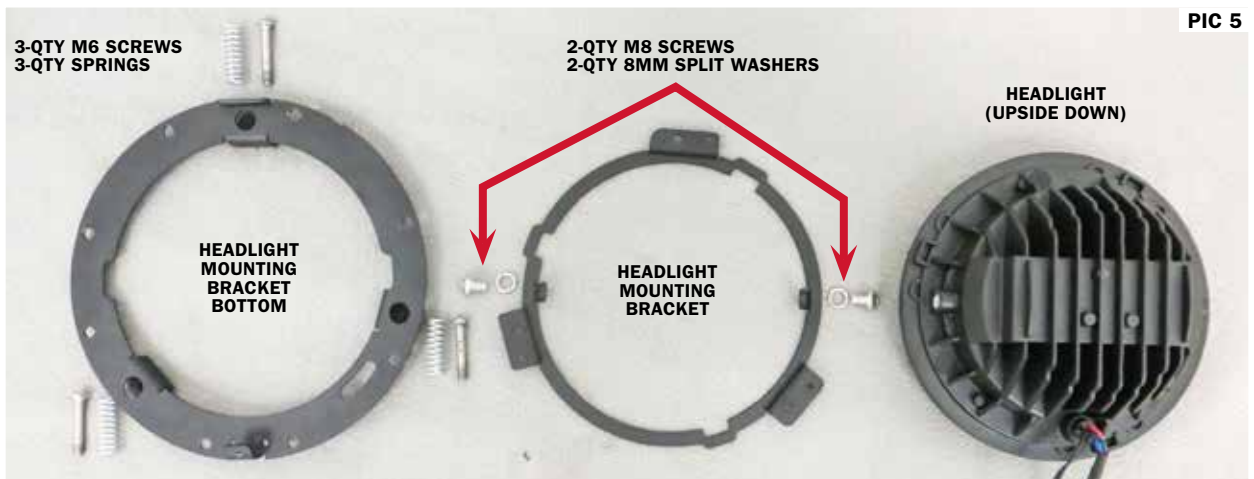

- STEP 5** Refer to PIC 6 and 7. With the brackets of the Headlight Mount Bracket facing up, feed the wires of the headlight through the bracket and place it on top of the headlight.

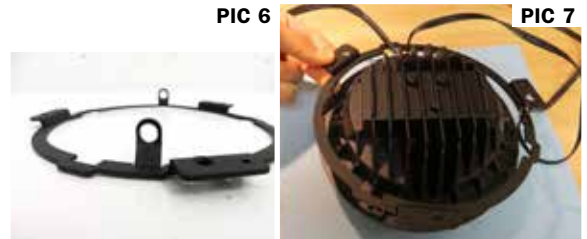

- STEP 6** Refer to PIC 8. Align the two inner brackets of the Headlight Mounting Bracket with the holes on each side of the Headlight. Apply loc-tight to M8 screw threads. Fasten the Mounting Bracket to the Headlight by placing a 8MM split washer on each of the M8 screws and inserting them through the aligned side holes, one on each side. Fully tighten hardware.



## INSTALLATION INSTRUCTIONS

### ORBIT PRISM 7" LED HEADLIGHT

2461

-CONTINUED-

**STEP 7** Refer to PIC 9. Locate the Mounting Bracket Bottom. With the protruding bracket side placed down on a flat surface, feed the headlight wire through the mount and place the headlight in the mount right side up.



**STEP 8** Refer to PIC 10 through 12. Align the bracket holes of the two mounts. On the Bottom Mounting Bracket, place a spring into each hole with a bracket on the underside. Apply loc-tight to M6 screw threads. Place a M6 screw in each of the holes of the Mounting Bracket attached to the headlight.

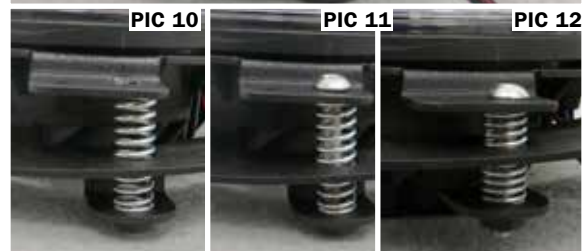

Press the two brackets together, and lightly tighten the screw until brackets are fastened together.

**STEP 9 FOR '14-UP HARLEY DAVIDSON ELECTRA GLIDES, STREET GLIDES, AND TRIKES**  
Refer to PIC 13. Wiring Adapter (P/N 5487 sold separately) is needed for installation.

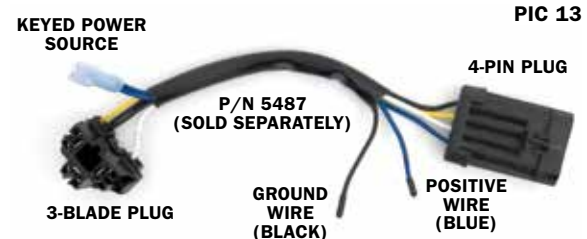

**FOR '14-UP HARLEY DAVIDSON ROAD KINGS**  
Refer to PIC 14. Wiring Adapter (P/N 5478 sold separately) is needed for installation.



**FOR ALL OTHER HARLEY DAVIDSONS AND OTHER MOTORCYCLES - SKIP TO STEP 10**

**STEP 10** Locate the provided Bluetooth Harness.

**FOR '14-UP TOURING AND TRIKE HARLEYS USING WIRE ADAPTER 5487.** Refer to PIC 15 and 16. Connect the 4-Pin Wiring Adapter plug to the motorcycle's headlight DC receptacle. Locate the red and black wires attached to the Bluetooth Harness. Using the butt connectors, provided with the adapter, connect the red wire of the harness with the blue wire of the Wiring Adapter, and the black wire with the black wire.

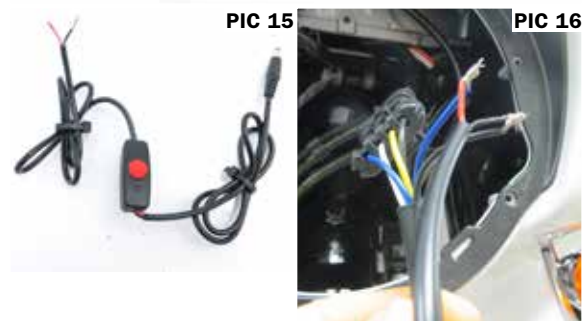

**FOR '14-UP ROAD KINGS USING WIRE ADAPTER 5478.** Connect the High Beam and Low Beam Wiring Adapter plug to motorcycle's headlight DC receptacles. Fasten the, provided with the adapter, spaded connector to the red wire of the harness. Connect the spaded red wire to the blue key power source wire on the adapter. Locate a ground wire from the motorcycle and splice the black wire of the harness to it.

**FOR ALL OTHER HARLEYS AND OTHER MOTORCYCLES.** From the motorcycle, locate a switched power wire and splice the red (positive) harness wire to it. Locate a ground wire and splice the black wire of the harness to it. Refer to the motorcycle's service manual for assistance with the wires.

## INSTALLATION INSTRUCTIONS

### ORBIT PRISM 7" LED HEADLIGHT

2461

-CONTINUED-

**STEP 11** Refer to PIC 17 and 18. Locate Bluetooth Controller. Connect the Bluetooth "In" outlet to the Bluetooth Harnesses' plug.



**STEP 12** Refer to PIC 19, 20, and 21. Locate the Headlight assembly. Connect the headlight's 4-pin LED plug to the Bluetooth Controller's LED outlet. Pull the plastic nut over the threads of the other connector and twist until they are fully fastened together.

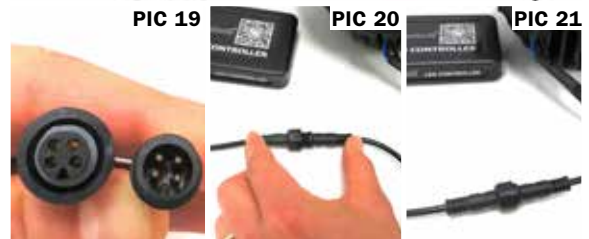

**STEP 13** Refer to PIC 22 and 23. Connect the Headlight's three blade plug into the outlet attached to the Wire Adapter, or OEM headlight outlet.



**STEP 14** Refer to PIC 24 and 25. Reinstall main fuse, turn ignition on, and test light. To test L.E.D halo function, you will need to install Magic Light - BLE (Android and iOS compatible) app. Turn ignition off after testing.



**STEP 15** Refer to PIC 26 and 27. Tuck wiring into headlight housing. Align the headlight bracket assembly so that "DOT" is readable and is positioned on the bottom of the light. Place the assembly on the motorcycle. Use the OEM hardware that was removed in Step 3 to fasten the headlight to the motorcycle.



## INSTALLATION INSTRUCTIONS

### ORBIT PRISM 7" LED HEADLIGHT

2461

-CONTINUED-

#### STEP 16 ADJUSTING HEADLIGHT AIM

Refer to FIG 1. Choose a wall that is in minimal light. Park motorcycle on flat surface perpendicular and 25ft away from the wall, measuring from the motorcycle's front axle to the wall. Using masking tape and a level, create a vertical line on the wall. With the motorcycle positioned up right measure the distance from the ground to the center of the high beam bulb. Take that measurement and subtract 2 inches from it. Using that final measurement create a horizontal line over the vertical line on the wall.

The headlight is aligned when the hot spot of the light beam is centered over the intersection of the two lines. Verify the headlight's alignment and adjust it if necessary.

Refer to PIC 28 and 29. Adjust the aim of the headlight by loosening or tightening the three loaded screws attaching the two headlight brackets together.

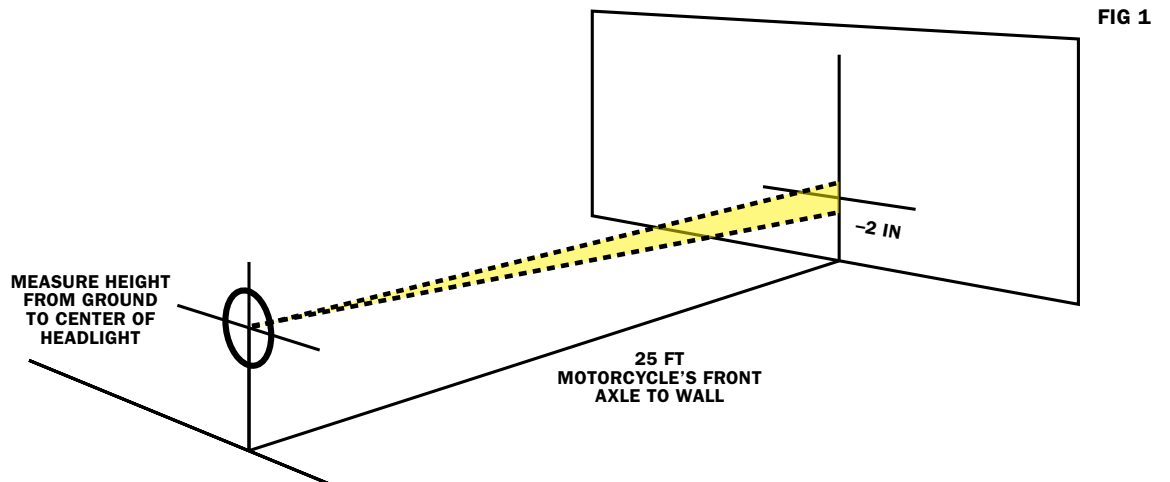

#### STEP 17

Refer to PIC 30. **FOR HARLEY MOTORCYCLES.** Reinstall headlight trim, using the trim that was removed in Step 2, and the provided Self Tapped Screw.

**FOR ALL OTHER MOTORCYCLES.** Reinstall any parts that were removed previously to taking the OEM headlight out.



## INSTALLATION INSTRUCTIONS

### ORBIT PRISM 7" LED HEADLIGHT

2461

-CONTINUED-

#### WARNING

VISIBILITY IS A MAJOR CONCERN FOR MOTORCYCLISTS. A LIGHT MALFUNCTION COULD RESULT IN DEATH OR SERIOUS INJURY. ENSURE PROPER LIGHT OPERATION BEFORE RIDING THE MOTORCYCLE.

#### NOTICE

IT IS THE INSTALLER'S RESPONSIBILITY TO ENSURE THAT ALL OF THE FASTENERS (INCLUDING PRE-ASSEMBLED) ARE TIGHTENED BEFORE OPERATION OF THE MOTORCYCLE. KURYAKYN WILL NOT PROVIDE WARRANTY COVERAGE ON PRODUCTS OR COMPONENTS LOST DUE TO IMPROPER INSTALLATION OR LACK OF MAINTENANCE. PERIODIC INSPECTION AND MAINTENANCE ARE REQUIRED ON ALL FASTENERS.



#### LIMITED WARRANTY

Kuryakyn warrants that any Kuryakyn products sold hereunder, shall be free of defects in materials & workmanship for a period of one (1) year from the date of purchase by the consumer excepting the following provisions:

1. Kuryakyn shall have no obligation in the event the customer is unable to provide a receipt showing the date the customer purchased the product(s).
2. The product must be properly installed, maintained & operated under normal conditions.
3. Kuryakyn shall not be liable for any consequential & incidental damages, including labor & paint, resulting from failure of a Kuryakyn product, failure to deliver, delay in delivery, delivery in nonconforming condition, or for any breach of contract or duty between Kuryakyn & a customer.
4. Kuryakyn products are often intended for use in specific applications. Kuryakyn makes no warranty if a Kuryakyn product is used in applications other than intended.
5. Kuryakyn electrical products are warranted for one (1) year from the date of purchase by the consumer. L.E.D.'s contained in components of Kuryakyn products will be warranted for defects in materials & workmanship for 3 years from the date of purchase whereas all other components shall be warranted for one (1) year.
6. All warranty claims must be directed to the place of purchase. Merchandise sold through internet auction sites or any other unauthorized reseller shall not carry a Kuryakyn warranty. If unsure, please contact the place of purchase to verify they are an authorized Kuryakyn reseller.

#### RETURN POLICY

Merchandise determined to be defective may be returned up to one year from the date of purchase. Returns must be processed through original seller. Returned merchandise for any other reason other than warranty claims must be in like new condition & subject to a 20% restocking fee. All returns are subject to inspection for determination of full or partial credit. Any returned part that shows evidence of being used or installed contrary to manufacturer's instructions, &/or subjected to improper handling, packaging or return shipping by the customer, will not be eligible for exchange, refund or warranty consideration. All returned electrical items will be inspected & tested. If electrical item is deemed functional, no credit will be issued & item will be returned. All sales are final on discontinued or closeout merchandise.

©2015 KURYAKYN HOLDINGS, LLC ALL RIGHTS RESERVED

KURYAKYN, KURYAKYN K logo and the marks appearing on this instruction sheet are registered and common law trademarks of Kuryakyn Holdings except noted third-party trademarks. A full listing of trademarks and trademark registrations owned by Kuryakyn Holdings can be found at [www.kuryakyn.com/legal-notice](http://www.kuryakyn.com/legal-notice).

Emissions Notice: The California Air Resources Board (CARB) does not permit the use of aftermarket emission-related parts(s) that alter the performance of OEM emission-related devices unless CARB has issued an Executive Order, other than on racing vehicles on closed courses. Check your local laws and manufacturer's information.

Listed Manufacturers and product model names are for reference only. All product and company names are trademarks or registered trademarks of their respective holders. Use of them does not imply any affiliation with or endorsement by them. All specifications are subject to change without notice.

For additional information on third-party product and company names, please consult our Web page at [www.kuryakyn.com/legal-notice](http://www.kuryakyn.com/legal-notice)